

STANDARD EQUIPMENT

ENGINE

- Engine, HINO J08E-UN, Diesel engine with turbocharger and intercooler
- Automatic engine deceleration
- Auto Idle Stop (AIS)
- Batteries (2 x 12V - 96Ah)
- Starting motor (24V - 5 kW), 50 amp alternator
- Removable clean-out screen for radiator
- Automatic engine shut-down for low engine oil pressure
- Engine oil pan drain valve
- Double element air cleaner

CONTROL

- Working mode selector (H-mode and S-mode)
- Power Boost

SWING SYSTEM & TRAVEL SYSTEM

- Swing rebound prevention system
- Straight propel system
- Two-speed travel with automatic shift down
- Sealed & lubricated track links
- Grease-type track adjusters
- Automatic swing brake

HYDRAULIC

- Arm regeneration system
- Auto warm up system
- Aluminum hydraulic oil cooler

MIRRORS & LIGHTS

- Two rearview mirrors
- Three front working lights

CAB & CONTROL

- Two control levers, pilot-operated
- Tow eyes
- Horn, electric
- Integrated left-right slide-type control box
- Cab, all-weather sound suppressed type
- Cab light (interior)
- Large cup holder
- Detachable two-piece floor mat
- 7-way adjustable suspension seat
- Retractable seatbelt
- Headrest
- Handrails
- Heater and defroster
- Intermittent windshield wiper with double-spray washer
- Skylight
- Tinted safety glass
- Pull-type front window and removable lower front window
- Easy-to-read multi-display monitor
- Automatic air conditioner
- Emergency escape hammer
- Radio, AM/FM Stereo with speakers

OPTIONAL EQUIPMENT

- | | |
|---|--|
| <ul style="list-style-type: none"> ■ Wide range of bucket ■ Various optional arms ■ Wide range of shoes ■ Cab light ■ Travel alarm | <ul style="list-style-type: none"> ■ Additional track guide ■ Under cover ■ Nibbler & Breaker hydraulic piping ■ Extra hydraulic piping ■ Front-guard protective structures |
|---|--|

Note: Standard and optional equipment may vary. Consult your KOBELCO dealer for specifics.

Hydraulic Excavators

SK330
SK350^{LC}

- Bucket Capacity:
1.2 – 1.8 m³ ISO heaped
- Engine Power:
200 kW /2,100 min⁻¹ (ISO14396)
- Operating Weight:
34,100 kg–SK330
35,000 kg–SK350LC



Note: This catalog may contain attachments and optional equipment that are not available in your area. And it may contain photographs of machines with specifications that differ from those of machines sold in your areas. Please consult your nearest KOBELCO distributor for those items you require. Due to our policy of continuous product improvements all designs and specifications are subject to change without advance notice. Copyright by **KOBELCO CONSTRUCTION MACHINERY CO., LTD.** No part of this catalog may be reproduced in any manner without notice.

KOBELCO CONSTRUCTION MACHINERY CO., LTD.

17-1, Higashigotanda 2-chome, Shinagawa-ku, Tokyo 141-8626 JAPAN
Tel: +81 (0) 3-5789-2146 Fax: +81 (0) 3-5789-2135
www.kobelco-kenki.co.jp/english_index.html

Inquiries To:

The Power Wave of Change



When we set out to design our new hydraulic excavators, we kept our eyes on the big picture. Of course we wanted machines with greater digging capacity. But they also had to be fuel-efficient and economical, while imposing less of a burden on the local and global environments. Applying our advanced technologies, we developed KOBELCO's SK series, an entirely new kind of excavator that beautifully balances all the demands of today's construction industry. Lean and efficient with capacity to spare, these sleek powerhouses bring a whole new style to the worksite while setting new standards for environmental responsibility.

NEXT-3E



Pursuing the "Three E's"
**The Perfection of Next-Generation,
Network Performance**

Enhancement

Greater Performance Capacity

- New hydraulic circuitry minimizes pressure loss
- High-efficiency, electronically controlled Common Rail Fuel Injection Engine
- Powerful travel and arm/bucket digging force

Economy

Improved Cost Efficiency

- Advanced power plant that reduces fuel consumption
- Easy maintenance that reduces upkeep costs
- High structural durability and reliability that retain machine value longer

Environment

Features That Go Easy on the Earth

- Auto Idle Stop as standard equipment
- Noise reduction measures (with improvement of the sound quality) minimize noise and vibration

Efficient Performance!

Amazing Productivity with a 27 % Increase in Work Volume and “Top-Class” Cost-Performance

Work Volume*
27 % increase in work volume using the same amount of fuel. (H-Mode)

Fuel Consumption*
18 % decrease in fuel consumption even when performing more work volume. (S-Mode)

“Top-Class” Powerful Digging

Max. arm crowding force: **165 kN** {16.8 tf}

Max. arm crowding force with power boost: **181 kN** {18.5 tf}

Max. bucket digging force: **222 kN** {22.6 tf} ↑

Max. bucket digging force with power boost: **244 kN** {24.9 tf} ↑

Powerful Travel

Travel torque: increased by **13 %** ↑

Drawbar pulling force: **322 kN** {32.8 tf} ↑

Greater Swing Power, Shorter Cycle Times

Swing torque: increased by **7 %** ↑

Swing speed (10.0 min⁻¹): **16 %** faster ↑

Significant Extension of Continuous Working Hours

The combination of a large-capacity fuel tank and excellent fuel efficiency delivers an impressive 22% increase in continuous operation hours.**

Fuel tank: **580L**
22 % ↑

Light Lever Operation

It takes 10% less effort to move the control levers, so that operators can work longer hours with less fatigue.

10 %
Less



NEXT-3E Technology Next-Generation Electronic Engine Control

The high-pressure, common-rail fuel-injection engine features adjustable control to maximize fuel efficiency and provide powerful medium/low-speed torque. The result is a highly fuel-efficient engine.



Simple Select: Two Digging Modes



- H-Mode** For heavy duty when a higher performance level is required.
- S-Mode** For normal operations with lower fuel consumption.

Attachment Mode Selector Switch (Optional)
 There's a choice of three different hydraulic circuits, to accommodate bucket, crusher or breaker, and the desired attachment mode can be selected with a switch, which automatically configures the selector valve. All attachment modes can be used in either S-mode or H-mode.



Seamless, Smooth Combined Operations

The SK series machines have inherited the various systems that make inching and combined operations easy and accurate, with further refinements that make a good thing even better. Leveling and other combined operations can be carried out with graceful ease.

- Electronic Active Control System
- Arm regeneration system
- Boom lowering regeneration system
- Variable swing priority system
- Swing rebound prevention system

NEXT-3E Technology New Hydraulic System



Rigorous inspections for pressure loss are performed on all components of the hydraulic piping, from the first spool of the control valve to the connectors. This regimen, combined with the use of a new, high-efficiency pump, cuts energy loss to a minimum.

NEXT-3E Technology Total Tuning Through Advanced ITCS Control

The next-generation engine control is governed by a new version of ITCS, which responds quickly to sudden changes in hydraulic load to ensure that the engine runs as efficiently as possible with a minimum of wasted output.

ITCS (Intelligent Total Control System) is an advanced, computerized system that provides comprehensive control of all machine functions.

*The value shows results from actual measurements taken by KOBELCO when compared with previous KOBELCO models.

**The value shows results from actual measurements taken by KOBELCO for continuous operation in S Mode, compared with previous models. Results vary depending on the method of operation and load conditions.

The Value and Quality of Sturdy Construction!

Stable Attachment Strength

Forged and cast steel components are used throughout. The standard arm and boom also meet specifications that were classified as "reinforced" on previous KOBELCO models to ensure reliable strength.

Emergency Acceleration (Dial) Permits Continued Operation in the Unlikely Event of Malfunction



If unexpected trouble is experienced with the ITCS mechatronic control system, the machine can still be operated using the emergency acceleration system. Digging modes are also automatically relayed to an emergency system so that digging can continue temporarily until a service person arrives to repair the primary system.

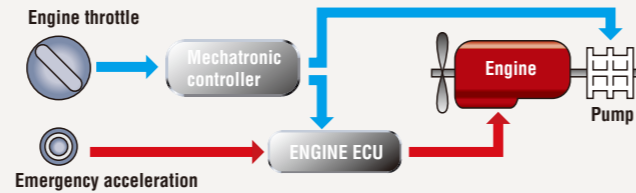

Cast steel boom foot boss

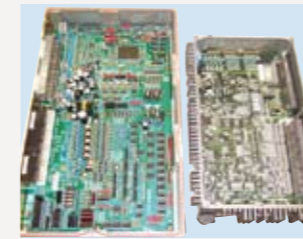

New MCU Conventional MCU

Newly designed MCU

- Vertical alignment and sealed cover gives better protection from water and dust
- Integration in base plate boosts assembly quality
- Reliable fixture to base plate

Countermeasures Against Electrical System Failure

All elements of the electrical system, including controller, have been designed for enhanced reliability.

Large-Capacity Pump Resists Overheating

The pump capacity has been **22%** increased by compared with previous models.

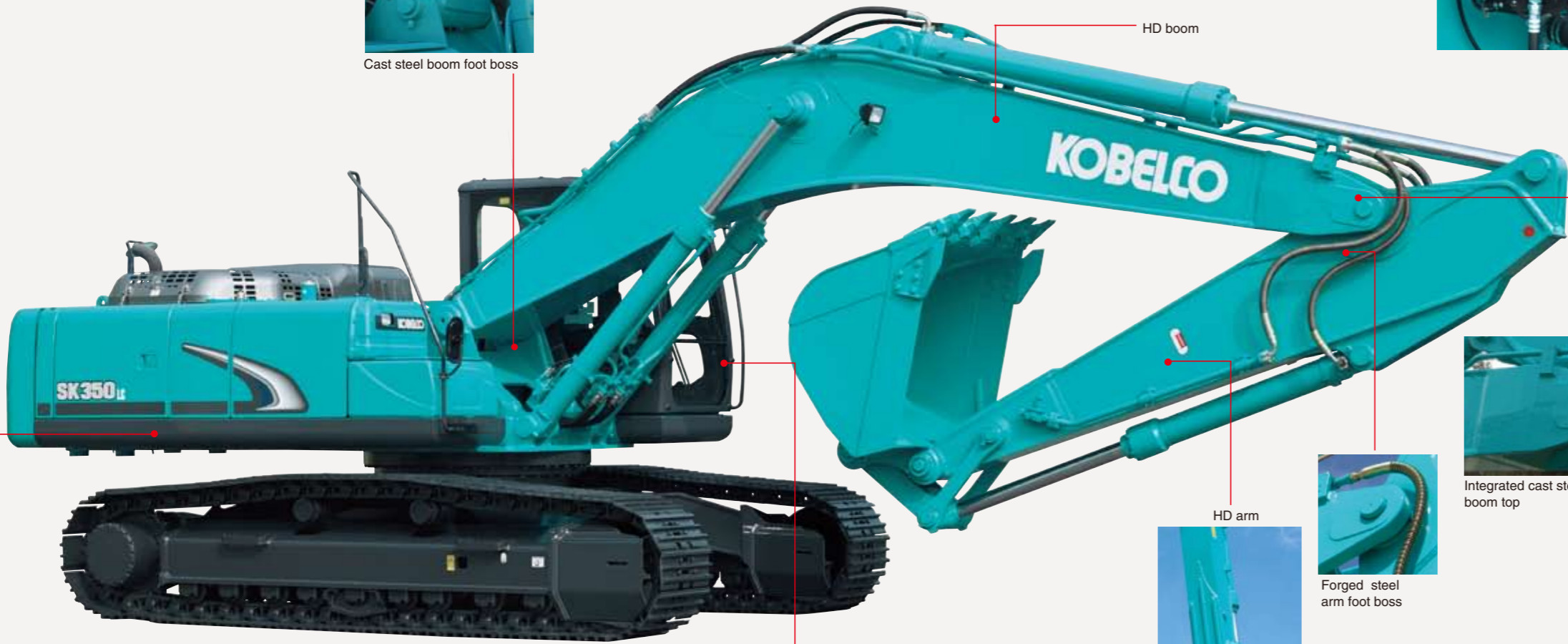

Enhanced Upper Carbody Strength

The structure of the lower portion of the upper frame has been reassessed and the undercover area has been minimized for further strength.



Durability That Retains Machine Value Five and Ten Years in the Future

- New operator's seat covered in durable material
- High-quality urethane paint
- Easily repaired bolted hand rails



Reinforced arm

Designed for the Environment and the Future!

Auto Idle Stop Provided as Standard Equipment

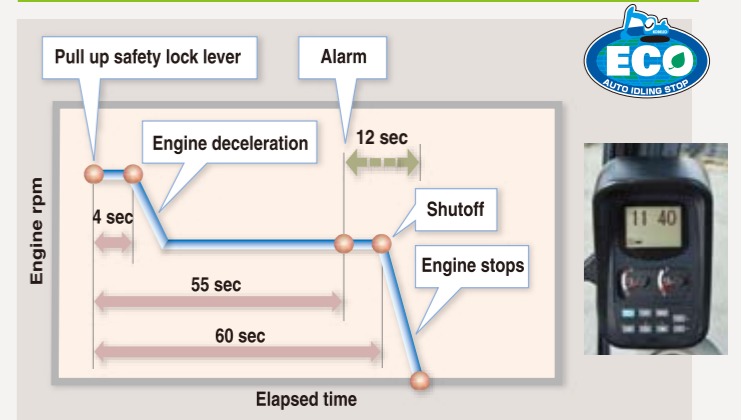

This function saves fuel and cuts emissions by shutting down the engine automatically when the safety lock lever is pulled up. It also stops the hourmeter, which helps to retain the machine's asset value.

Automatic Acceleration/Deceleration Function Reduces Engine Speed

Engine speed is automatically reduced when the control lever is placed in neutral, effectively saving fuel and reducing noise and exhaust emissions. The engine quickly returns to full speed when the lever is moved out of neutral.

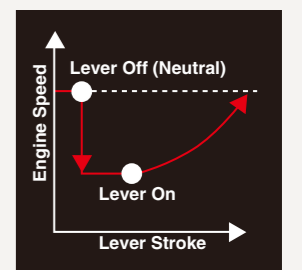

Low Noise Level and Mild Sound Quality

The electronically controlled common-rail engine has a unique fuel injection system that runs quietly. Also, the hydraulic pumps have been redesigned to produce a more pleasant sound during pressure relief.

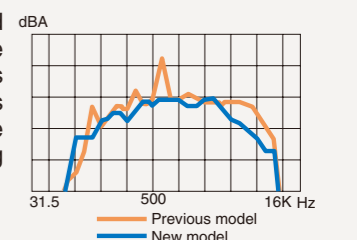

Meets EMC (Electromagnetic Compatibility) Standards in Europe.

Measures have been taken to ensure that the SK series machines do not cause electro-magnetic interference.

“On the Ground” Maintenance!

Comfortable “On the Ground” Maintenance

The machine layout was designed with easy inspection and maintenance in mind.



Access through the right side cover

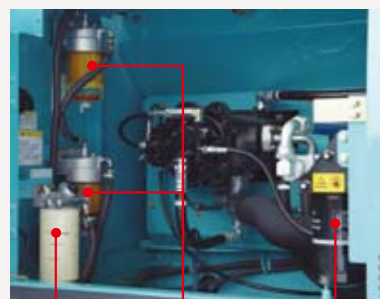

The fuel filter with built-in water separator functions in two ways by removing large contaminants and separating out water.

Main fuel filter Pre-fuel filter (with built-in water separator) Engine oil filter

Quick Oil Drain Valves for Quick Maintenance



Quick drain valve



Fuel drain valve

More Efficient Maintenance Inside the Cab



● Detachable two-piece floor mat with handles for easy removal. A floor drain is located under the mat.



● Easy-access fuse box. More finely differentiated fuses make it easier to locate malfunctions.

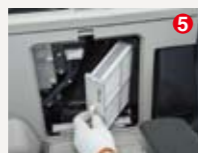

● Air conditioner filter can be easily removed without tools for cleaning.



● Hour meter can be checked while standing on the ground.



● Large-capacity tool box can hold up to three pails.

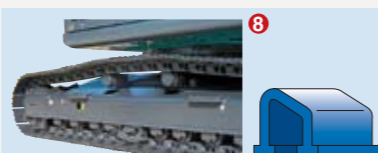

● Special crawler frame design is easily cleaned of mud.

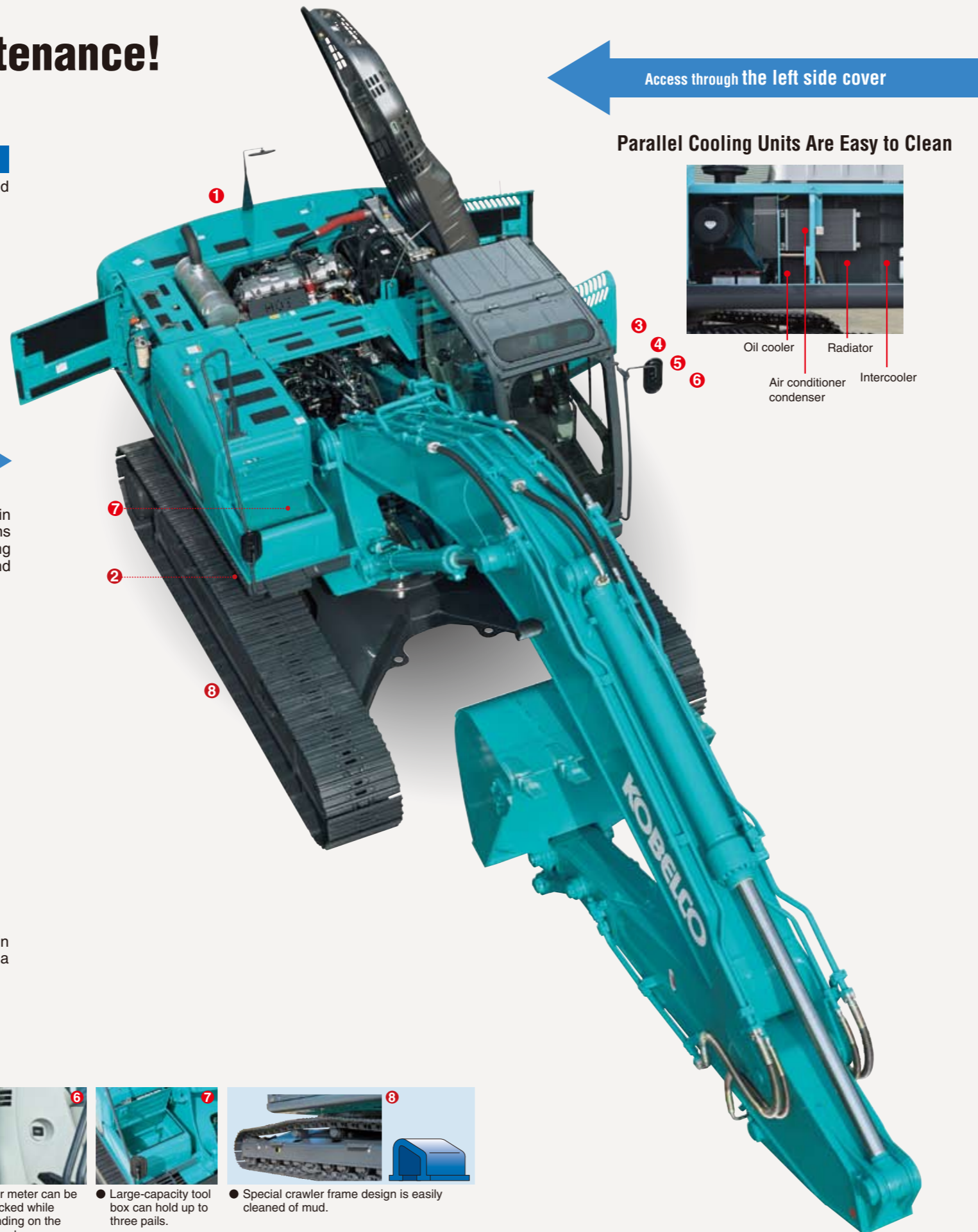

Access through the left side cover

Parallel Cooling Units Are Easy to Clean

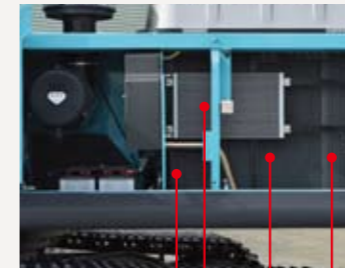

Oil cooler Radiator Intercooler
Air conditioner condenser

Long-Life Hydraulic Oil Reduces Replacement Costs

Long-life hydraulic oil:
5,000 hours

The long-life hydraulic oil features a base oil with excellent demulsification, with optimized wear-resistant additives and antioxidants that help to boost the service life to 5,000 hours and greatly reduce the number of changes necessary.

Highly Durable Super-fine Filter



● Super-fine filter

The high-capacity hydraulic oil filter incorporates glass fiber with superior cleaning power and durability. With a replacement cycle of 1,000 hours and a construction that allows replacement of the filter element only, it's both highly effective and highly economical.

Double-Element Air Cleaner as Standard



The large-capacity element features a double-filter structure that keeps the engine running clean even in dusty environments.

Air cleaner (double element)

New-Design Fuel Filter Catches 95% of Dust and Impurities



The large-capacity fuel filter is designed specifically for common rail engines. With an increased filtering performance to 2-micron precision, this high-grade filter catches 95% of all dust particles and other impurities in the fuel.

Monitor Display with Essential Information for Accurate Maintenance Checks



- Displays only the maintenance information that's needed, when it's needed.
- Self-diagnostic function that provides early-warning detection and display of electrical system malfunctions.
- Record previous breakdowns, including irregular and transient malfunctions.

Choice of 16 Languages for Monitor Display



With messages including those requiring urgent action displayed in the local language, users in all parts of the world can work with greater peace of mind.

充電不良	Lichtmaschine defekt	CHARGE ERROR	CHARGE ERROR
Chinese	German	English	English (US)
ERREUR DE CHARGE	PENGISIAN BATT. RUSAK		ERRORE DI CARICA
French	Indonesian	ISO	Italian
チャージ	KESALAHAN CAS	အမှားပမာဏ	ERRO DE CARGA
Japanese	Malay	Myanmar(Bruese)	Portuguese
ERROR EN CARGA	အမှားပမာဏ	Sạc Bị Lỗi	
Spanish	Thai	Vietnamese	

Designed from the Operator's Point of View

Newly Designed "Big Cab"

The new "Big Cab" provides a roomy operating space with plenty of legroom, and the door opens wide for easy entry and exit. As well as giving a wide, open view to the front, the cab has increased window areas on both sides and to the rear, for improved visibility in all directions.



Wide-Access Cab Aids Smooth Entry and Exit



Easy entry and exit assured with wider cab entry and safety lock lever integrated with mounting for control lever.

Excellent Visibility



The wide open view to the front combines with minimized blind spots around the machine for greater onsite safety.



Photo includes optional pedals for N&B.

In-Cab Noise is Reduced by 4dB



Compared with previous models.

Newly Designed Information Display Prioritizes Visual Recognition

The analog gauge provides information that's easy to read regardless of the operating environment. The information display screen has been enlarged, and a visor is attached to further enhance visibility.



Creating a Comfortable Operating Environment



- Double slide seat
- Powerful automatic air conditioner
- Two-speaker AM/FM radio with station select
- One-touch lock release simplifies opening and closing the front window
- Large cup holder
- Spacious luggage tray

Imagining Possible Scenarios and Preparing in Advance

ROPS Cab

The newly developed, ROPS (Roll-Over Protective Structure)-compliant cab clears ISO standards (ISO-12117-2: 2008) and ensures greater safety for the operator should the machine tip over.



Safety Features That Take Various Scenarios into Consideration



- Firewall separates the pump compartment from the engine
- Hammer for emergency exit
- Thermal guard prevents contact with hot components during engine inspections
- Hand rails meet European standards
- Retractable seatbelt requires no manual adjustment

Engine

Model	HINO J08E-UN
Type:	Direct injection, water-cooled, 4-cycle diesel engine with turbocharger, intercooler
No. of cylinders:	6
Bore and stroke:	112 mm X 130 mm
Displacement:	7.684 L
Rated power output:	200 kW/2,100 min ⁻¹ (ISO14396:Without fan) 188 kW/2,100 min ⁻¹ (ISO9249:With fan)
Max. torque:	998 N·m/1,600 min ⁻¹ (ISO14396:Without fan) 969 N·m/1,600 min ⁻¹ (ISO9249:With fan)

Hydraulic System

Pump	
Type:	Two variable displacement pumps + 1 gear pump
Max. discharge flow:	2 X 294 L/min, 1 X 20 L/min
Relief valve setting	
Boom, arm and bucket:	34.3 MPa {350 kgf/cm ² }
Power Boost:	37.8 MPa {385 kgf/cm ² }
Travel circuit:	34.3 MPa {350 kgf/cm ² }
Swing circuit:	29.0 MPa {296 kgf/cm ² }
Control circuit:	5.0 MPa {50 kgf/cm ² }
Pilot control pump:	Gear type
Main control valves:	8-spool
Oil cooler:	Air cooled type

Swing System

Swing motor:	Axial-piston motor
Brake:	Hydraulic; locking automatically when the swing control lever is in the neutral position
Parking brake:	Hydraulic disc brake
Swing speed:	10.0 min ⁻¹ {rpm}
Tail swing radius:	3,500 mm
Min. front swing radius:	4,370 mm

Attachments

Backhoe bucket and arm combination

Use	Backhoe bucket					
	Normal digging	Light-duty	Heavy digging			
Bucket capacity	Heaped (ISO 7451) m ³	1.2	1.4	1.6	1.8	1.4
	Struck (ISO 7451) m ³	0.84	1.0	1.2	1.4	1.0
Opening width	With side cutter mm	1,240	1,420	1,570	—	1,390
	Without side cutter mm	1,110	1,300	1,450	1,680	1,330
No. of bucket teeth		4	5	5	5	5
Bucket weight kg		930	1,070	1,100	1,200	1,300
Combinations	2.6 m short arm	○	○	○	△	○
	3.3 m standard arm	○	○	○	×	○
	4.15 m long arm	○	△	×	×	×

○ Recommended △ Loading only × Not recommended

Travel System

Travel motors:	2 X axial-piston, two-step motors
Travel brakes:	Hydraulic brake per motor
Parking brakes	Oil disc brake per motor
Travel shoes:	45 each side (SK330)
	48 each side (SK350LC)
Travel speed:	5.6/3.3 km/h
Drawbar pulling force:	322 kN {32.8 tf} (ISO7464)
Gradeability:	70 % {35°}
Ground clearance:	500 mm

Cab & Control

Cab	
All-weather, sound-suppressed steel cab mounted on the silicon-sealed viscous mounts and equipped with a heavy, insulated floor mat.	
Control	
Two hand levers and two foot pedals for travel	
Two hand levers for excavating and swing	
Electric rotary-type engine throttle	

Boom, Arm & Bucket

Boom cylinders:	140 mm X 1,550 mm
Arm cylinder:	170 mm X 1,788 mm
Bucket cylinder:	150 mm X 1,193 mm

Refilling Capacities & Lubrications

Fuel tank:	580 L
Cooling system:	31.1 L
Engine oil:	28.5 L
Travel reduction gear:	2 X 9.5 L
Swing reduction gear:	7.4 L
Hydraulic oil tank:	280 L tank oil level 353 L hydraulic system

Working Ranges

Range	Boom	6.50 m		
		Arm	Short 2.6 m	Standard 3.3 m
a - Max. digging reach		10.61	11.26	11.97
b - Max. digging reach at ground level		10.4	11.06	11.79
c - Max. digging depth		6.86	7.56	8.41
d - Max. digging height		10.26	10.58	10.7
e - Max. dumping clearance		7.06	7.37	7.53
f - Min. dumping clearance		3.32	2.62	1.77
g - Max. vertical wall digging depth		5.84	6.61	7.15
h - Min. swing radius		4.45	4.37	4.43
i - Horizontal digging stroke at ground level		4.21	5.82	7.21
j - Digging depth for 2.4 m (8') flat bottom		6.67	7.4	8.27
Bucket capacity ISO heaped m ³		1.6	1.4	1.2

Digging Force (ISO 6015)		Unit: kN (tf)		
Arm length		Short 2.6 m	Standard 3.3 m	Long 4.15 m
Bucket digging force		221 (22.5) 244 (24.9)*	222 (22.6) 244 (24.9)*	221 (22.5) 243 (24.8)*
	Arm crowding force	205 (20.9) 225 (22.9)*	165 (16.8) 181 (18.5)*	140 (14.3) 154 (15.7)*

*Power Boost engaged.

Dimensions

Arm length	Short 2.6 m	Standard 3.3 m	Long 4.15 m
A Overall length	11,280	11,200	11,230
B Overall height (to top of boom)	3,640	3,420	3,590
C Overall width	SK330	3,200	3,200
	SK350LC	3,200	3,200
D Overall height (to top of cab)	3,160	3,160	3,160
E Ground clearance of rear end	1,190	1,190	1,190
F Ground clearance	500	500	500

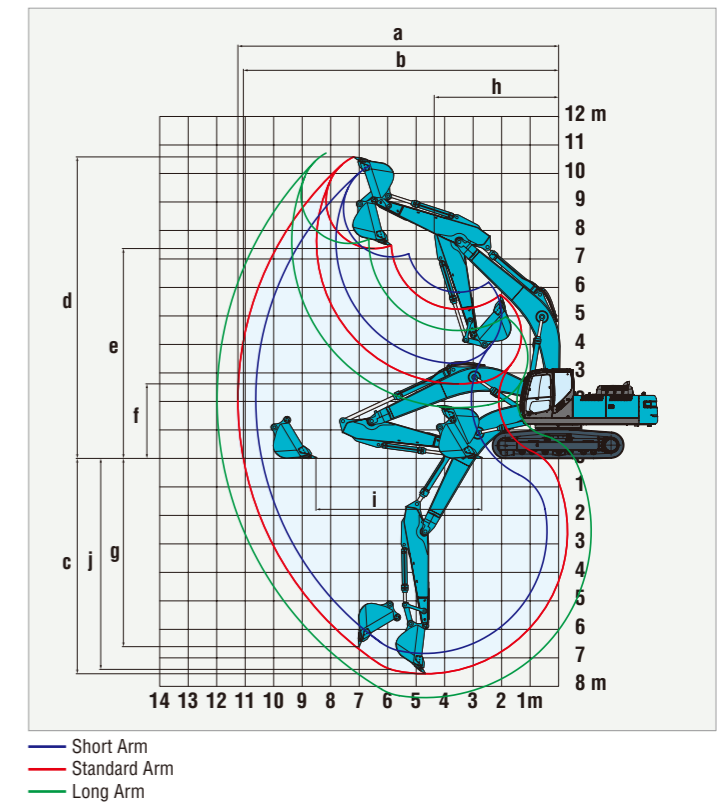

Unit: mm			
G Tail swing radius		3,500	3,500
G' Distance from center of swing to rear end		3,500	3,500
H Tumbler distance	SK330	3,730	3,720
	SK350LC	4,050	4,050
I Overall length of crawler	SK330	4,650	4,630
	SK350LC	4,980	4,980
J Track gauge	SK330	2,600	2,600
	SK350LC	2,600	2,600
K Shoe width		600/700/800	
L Overall width of upperstructure		2,950	2,950

* Without including height of shoe lug

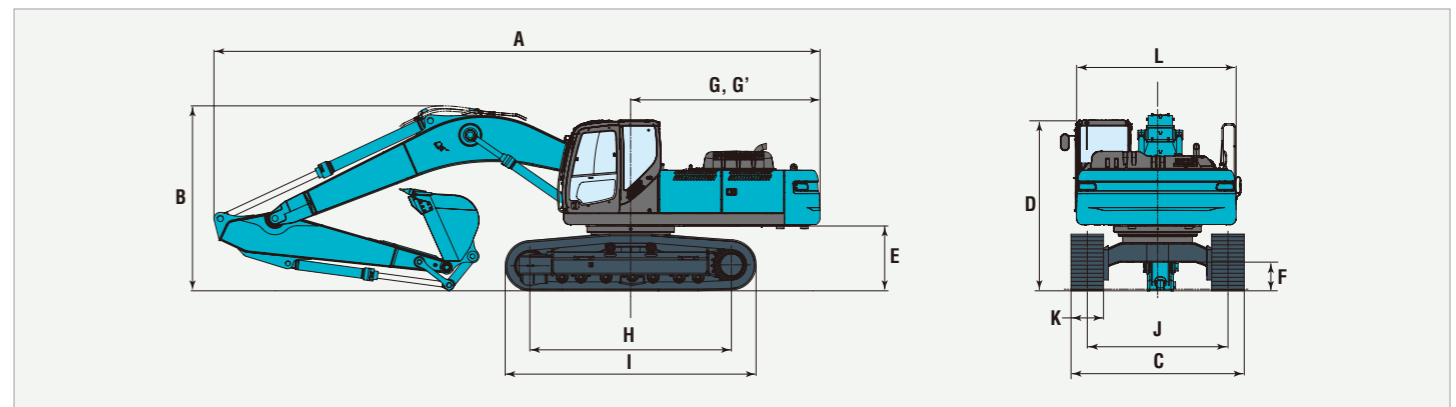

Operating Weight & Ground Pressure

In standard trim, with standard boom, 3.3 m arm, and 1.4 m³ ISO heaped bucket

Shaped	Shoe width mm		Triple grouser shoes (even height)		
			600	700	800
Overall width	mm	SK330	3,200	3,300	3,400
		SK350LC	3,200	3,300	3,400
Ground pressure	kPa (kgf/cm ²)	SK330	69 (0.70)	60 (0.61)	53 (0.54)
		SK350LC	65 (0.66)	57 (0.58)	50 (0.51)
Operating weight	kg	SK330	34,100	34,800	35,200
		SK350LC	35,000	35,900	36,300

